



**A propos**

- Confection 3 fils LSF (Low Shrinkage Fleece) : résistance et stabilité au lavage.
- Large choix de couleurs.
- Surface douce et intérieur enveloppant.

85% coton biologique / 15% polyester recyclé post-consumer. Coton peigné ringspun. Coupe droite. Lavé aux enzymes. Molleton gratté 3 fils LSF (Low Shrinkage Fleece : molleton pré-rétréci). 1/2 lune au dos. Poche kangourou. Bord cote 1 x 1 bas de vêtement et bas de manches. Double surpiqûre bas de manches, emmanchures, bas de vêtement et 1/2 lune. Bande de propreté intérieur encolure dos. Capuche doublée en matière principale avec point d'arrêt cordon. Cordon rond avec embouts et oeillets en métal recyclé. La couleur Raw Natural se distingue par son aspect brut visuellement texturé, parsemée de fines particules visibles à l'œil nu.

 350 g/m<sup>2</sup> 

**Tailles**

 XXS XS S M L XL XXL 3XL 4XL

**Informations Complémentaires**

**Logistique**

**Pays d'origine**

**Code douanier**

 5

 20



BD - Bangladesh



61102099

**Certifications**



**Couleurs**







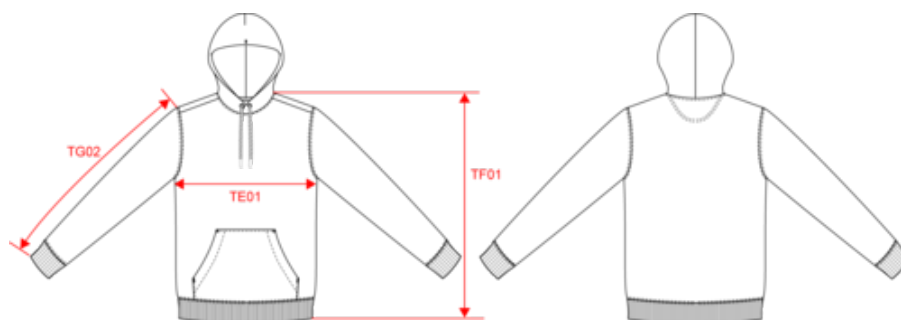















**NS401**  
Sweat-shirt écoresponsable à capuche unisexe

Dimensions (cm)



Mesures en cm	XXS	XS	S	M	L	XL	XXL	3XL	4XL
TE01 - 1/2 largeur poitrine à 1.5cm de l'emmanchure	46.00	49.00	52.00	55.00	58.00	61.00	64.00	67.00	70.00
TF01 - Hauteur totale de l'HSP	66.00	68.00	70.00	72.00	74.00	76.00	78.00	80.00	82.00
TG02 - Longueur manche longue	62.00	63.00	64.00	65.00	66.00	67.00	68.00	69.00	70.00

Informations Couleurs

 <b>Adriatic Blue</b> RVB : 76,130,144 Pantone C : 7475C Pantone TCX : 17-4716TCX	 <b>Almond Green</b> RVB : 145,146,127 Pantone C : 7536C Pantone TCX : 16-0213TCX	 <b>Antique Rose</b> RVB : 166,100,111 Pantone C : 4995C Pantone TCX : 17-1614TCX	 <b>Aquamarine</b> RVB : 153,173,190 Pantone C : 7542C Pantone TCX : 15-4008TCX	 <b>Black</b> RVB : 35,35,37 Pantone C : Black Pantone TCX : 19-4004TCX
 <b>Blue Sapphire</b> RVB : 5,87,124 Pantone C : 7700C Pantone TCX : 18-4231TCX	 <b>Celadon Green</b> RVB : 194,201,176 Pantone C : 5803C Pantone TCX : 13-0210TCX	 <b>Cherry Purple</b> RVB : 121,42,80 Pantone C : 506C Pantone TCX : 19-2432TCX	 <b>Cool Blue Heather</b> RVB : Pantone C : Based on 7544C Pantone TCX : Based on 17-4020TCX	 <b>Curcuma</b> RVB : 179,126,37 Pantone C : 146C Pantone TCX : 18-0935TCX
 <b>Dark camel</b> RVB : 137,110,83 Pantone C : 874C Pantone TCX : 18-1018TCX	 <b>Dark Cherry</b> RVB : 80,42,50 Pantone C : 497C Pantone TCX : 19-1627TCX	 <b>Forest Green</b> RVB : 41,62,48 Pantone C : 5605C Pantone TCX : 19-5918TCX	 <b>Gemstone Green</b> RVB : 9,132,117 Pantone C : 562C Pantone TCX : 17-5430TCX	 <b>Hibiscus Red</b> RVB : 134,27,47 Pantone C : 1815C Pantone TCX : 19-1656TCX
 <b>Iron Grey</b> RVB : 78,80,82 Pantone C : 446C Pantone TCX : 19-3901TCX	 <b>Ivory</b> RVB : 236,231,218 Pantone C : 7534C Pantone TCX : 11-0701TCX	 <b>Jade Green</b> RVB : 143,167,162 Pantone C : 5575C Pantone TCX : 16-5106TCX	 <b>Lemon Citrus</b> RVB : 237,237,180 Pantone C : Yellow 0131C Pantone TCX : 11-0710TCX	 <b>Light Turquoise</b> RVB : 13,169,202 Pantone C : 631C Pantone TCX : 16-4529TCX
 <b>Mineral Grey</b> RVB : 94,104,116 Pantone C : 431C Pantone TCX : 18-4215TCX	 <b>Moon Grey Heather</b> RVB : Pantone C : Based on 7539C Pantone TCX : Based on 16-5101TCX	 <b>Navy Blue</b> RVB : 41,45,57 Pantone C : 433C Pantone TCX : 19-4010TCX	 <b>Organic Khaki</b> RVB : 85,87,76 Pantone C : 418C Pantone TCX : 19-0312TCX	 <b>Paprika</b> RVB : 188,66,58 Pantone C : 7620C Pantone TCX : 18-1550TCX
 <b>Parma</b> RVB : 178,174,200 Pantone C : 5295C Pantone TCX : 14-3911TCX	 <b>Peacock Blue</b> RVB : 34,57,75 Pantone C : 7546C Pantone TCX : 19-4125TCX	 <b>Peacock Green</b> RVB : 0,87,95 Pantone C : 7476C Pantone TCX : 19-4916TCX	 <b>Petal Rose</b> RVB : 197,159,155 Pantone C : 7612C Pantone TCX : 15-1607TCX	 <b>Pineapple</b> RVB : 254,219,119 Pantone C : 120C Pantone TCX : 12-0736TCX
 <b>Poppy Red</b> RVB : 192,28,46 Pantone C : 711C Pantone TCX : 19-1763TCX	 <b>Raw Natural</b> RVB : 215,201,179 Pantone C : Based on 7500C Pantone TCX : Based on 13-10006TCX	 <b>Sea Blue</b> RVB : 17,75,131 Pantone C : 654C Pantone TCX : 19-4052TCX	 <b>Sienna</b> RVB : 135,97,86 Pantone C : 4715C Pantone TCX : 18-1320TCX	 <b>Sun Yellow</b> RVB : 220,178,78 Pantone C : 142C Pantone TCX : 14-0846TCX
 <b>Tangerine</b> RVB : 253,131,41 Pantone C : 1495C Pantone TCX : 16-1257TCX	 <b>Volcano Grey Heather</b> RVB : Pantone C : Based on 446C Pantone TCX : Based on 19-3906TCX	 <b>Wet Sand</b> RVB : 164,146,128 Pantone C : 7536C Pantone TCX : 17-1312TCX	 <b>White</b> RVB : 236,236,252 Pantone C : White Pantone TCX : 11-0601TCX	

Logistique



Sizes	Width (cm)	Height (cm)	Length (cm)	Net weight (kg)	Gross weight (kg)	Pieces/Box	Pieces/Bundle
XXS	40.00	36.00	60.00	10.7	12.3	20	5
XS	40.00	36.00	60.00	11.2	12.8	20	5
S	40.00	39.00	60.00	12	13.6	20	5
M	40.00	39.00	60.00	12.7	4.3	20	5
L	40.00	42.00	60.00	13.5	15.1	20	5
XL	40.00	42.00	60.00	14	15.6	20	5
XXL	40.00	44.00	60.00	15.2	16.8	20	5
3XL	40.00	44.00	60.00	16	17.6	20	5
4XL	40.00	47.00	60.00	17	18.6	20	5